



A Series Air Treatment Units

Ordering Code F.R.L Combination

AC	30	00	-	03	-	□
Filter+Regulator+Lubricator	10:1000 Valve Body Size 20:2000 Valve Body Size 30:3000 Valve Body Size 40:4000 Valve Body Size 50:5000 Valve Body Size	00:Three Elements (Filter+Regulator+Lubricator)		Port size M5:M5 01:G1/8" 02:G1/4" 03:G3/8" 04:G1/2" 06:G3/4" 10:G1"		Blank:Manual Drain Type D:Auto Drain Type Available Only For 2000 or Above



Specifications

Ensured Pressure Resistance	1.5MPa
Highest Working Pressure	1.0MPa
Ambient and Fluid Temperature	5~60°C
Filter Precision	25µm
Recommended Oil Use	Turbine No1 Oil ISOVG32
Cup Material	Polycarbonate
Protective Cover	AC1000~2000(Not Available)/AC2500~5000(Available)
Pressure Regulating Range	AC1000: 0.05~0.7MPa Ac2000~5000: 0.05~0.85MPa
Valve Type	With Overflow

Note:5、50 µ m etc are optional



Model	Specifications					Accessories			
	Assembly			Rated Flow (L/min)	Joint Size (G)	Pressure Gauge Size	Weight (kg)	Bracket (2 pcs)	Pressure Gauge
Filter	Regulator	Mist Separator							
AC1000-M5	AF1000	AR1000	AL1000	90	M5	1/16	0.26	Y10L	G27-10-R1
AC2000-01	AF2000	AR2000	AL2000	500	G1/8"	1/8	0.74	Y20L	G36-10-01
AC2000-02					G1/4"				
AC2500-02	AF3000	AR2500	AL3000	1500	G1/4"	1/8	1.04	Y30L	
AC2500-03					G3/8"				
AC3000-02	AF3000	AR3000	AL3000	2000	G1/4"	1/8	1.18	Y30L	
AC3000-03					G3/8"				
AC4000-03	AF4000	AR4000	AL4000	4000	G3/8"	1/4	2.14	Y40L	
AC4000-04					G1/2"				
AC4000-06	AF4000-06	AR4000-06	AL4000-06	4500	G3/4"	1/4	2.47	Y50L	G46-10-02
AC5000-06	AF5000	AR5000	AL5000	5000	G3/4"	1/4	3.82	Y60L	
AC5000-10					G1"				

A Series Air Filter Combination

Main Specification

AC1000-2000

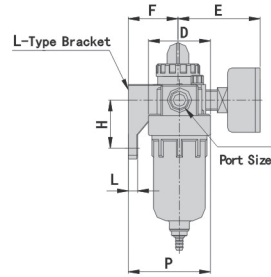
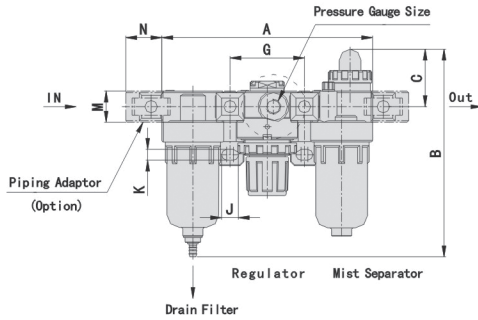

AC2500-5000

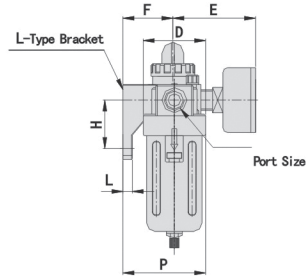
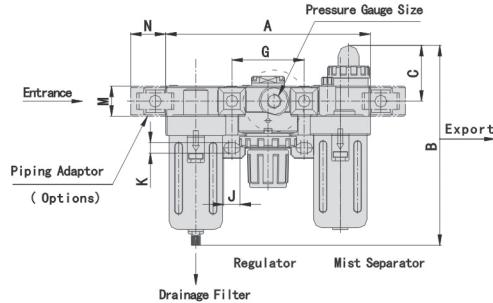

Model	Port Size	A	B	C	D	E	F	G	H	J	K	L	M	N	P
AC1000	M5	91	84.5	25.5	25	26	25	33	20	4.5	7.5	5	17.5	16	38.5
AC2000	1/8~1/4	140	125	38	40	56.8	30	50	24	5.5	8.5	5	22	23	50
AC2500	1/4~3/8	181	156.5	38	53	60.8	41	64	35	7	11	7	34.2	26	70.5
AC3000	1/4~3/8	181	156.5	38	53	60.8	41	64	35	7	11	7	34.2	26	70.5
AC4000	3/8~1/2	238	191.5	41	70	65.5	50	84	40	9	13	7	42.2	33	88
AC4000-06	3/4	253	193	40.5	70	69.5	50	89	40	9	13	7	46.2	36	88
AC5000	3/4~1	300	271.5	48	90	75.5	69.8	105	50	12	16	10.5	55.2	40	115

A Series Air Treatment Unit

Ordering Code FR.L Combination

AC	30	10	-	03	-	□
Filter Regulator+Lubricator	10:1000 Valve Body Size 20:2000 Valve Body Size 30:3000 Valve Body Size 40:4000 Valve Body Size 50:5000 Valve Body Size	Joint Size M5:M5 01:G1/8" 02:G1/4" 03:G3/8" 04:G1/2" 06:G3/4" 10:G1"	10:Two Elements (Filter Regulator+Lubricator)	Blank:Manual Drain Type D:Auto Drain Type Available Only For 2000 or Above		



Specifications

Ensured Pressure Resistance	1.5MPa
Highest Working Pressure	1.0MPa
Ambient and Fluid Temperature	5~60°C
Filter Precision	25µm
Recommended Oil Use	Turbine No1 Oil ISOVG32
Container Material	Polycarbonate
Protective Cover	AC1010~2010 (Not Available) / Ac3010~5010 (Available)
Pressure Regulating Range	AC1010: 0.05~0.7Mpa AC2010~5010: 0.05~0.85Mpa
Valve Type	With Overflow

Mark:5, 50µm etc. are optional



Model	Specification					Accessories		
	Filter Regulator	Mist Separator	Rated Flow (L/min)	Joint Size (G)	Pressure Gauge Size	Weight (kg)	Bracket	Pressure Gauge
AC1010-M5	AW1000	AL1000	90	M5	1/16	0.22	Y10T	G27-10-R1
AC2010-01	AW2000	AL2000	500	G1/8"	1/8	0.66	Y20T	G36-10-01
AC2010-02				G1/4"				
AC3010-02	AW3000	AL3000	1700	G1/4"	1/8	0.98	Y30T	
AC3010-03				G3/8"				
AC4010-03	AW4000	AL4000	3000	G3/8"	1/4	1.93	Y40T	
AC4010-04				G1/2"				
AC4010-06	AW4000-06	AL4000-06	3000	G3/4"	1/4	1.99	Y50T	G46-10-02
AC5010-06	AW5000	AL5000	4000	G3/4"	1/4	3.20	Y60T	
AC5010-10				G1"				

A Series Air Treatment Unit

Main Specifications

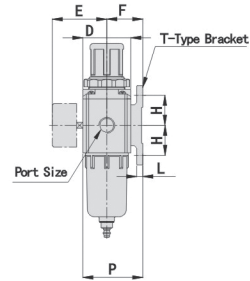
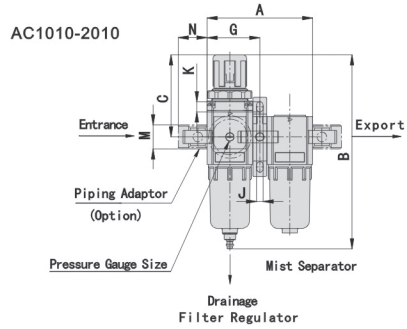

AC1010-2010

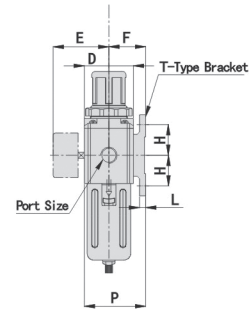
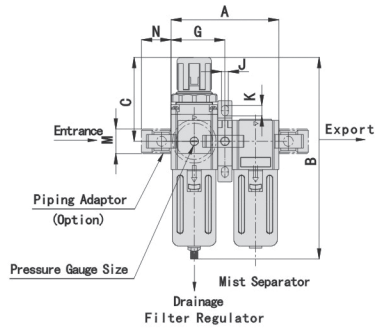

Model	Port Size	A	B	C	D	E	F	G	H	J	K	L	M	N	P
AC1010	M5	58	109.5	50.5	25	26	25	29	20	4.5	7.5	5	17.5	16	38.5
AC2010	1/8~1/4	90	164.5	78	40	56.8	30	45	24	5.5	8.5	5	22	23	50
AC3010	1/4~3/8	117	211	92.5	53	60.8	41	58.5	35	7	11	7	34.2	26	70.5
AC4010	3/8~1/2	154	262	112	70	70.5	50	77	40	9	13	7	42.2	33	88
AC4010-06	3/4	164	267	114	70	70.5	50	82	40	9	13	7	46.2	36	88
AC5010	3/4~1	195	338	116	90	75.5	69.8	97.5	50	12	16	10.5	55.2	40	115

A Series Air Treatment Unit

Ordering Code AF Series Air Filter

AF 30 00 - 03 - □

Filter

10:1000 Valve Body Size
20:2000 Valve Body Size
30:3000 Valve Body Size
40:4000 Valve Body Size
50:5000 Valve Body Size

Joint Size
M5:M5
01:G1/8"
02:G1/4"
03:G3/8"
04:G1/2"
06:G3/4"
10:G1"

Blank:Manual Drain Type
D:Auto Drain Type
Available Only For 2000 or Above



Specifications

Ensured Pressure Resistance	1.5MPa
Highest Working Pressure	1.0MPa
Ambient and Fluid Temperature	5~60°C
Filter Precision	25µm
Container Material	Polycarbonate
Protective Cover	AC1000~2000 (Not Available) / Ac3000~5000 (Available)
Valve Body	Aluminum Die Casting
Valve Core	Brass

Mark:5, 50 µm etc.are optional

Model	Specification				Accessories	Drain Function	Auto Drain Model
	Rated Flow (L/min)	Joint Size	Bowl capacity (cm ³)	Weight (kg)	Bracket		
AF1000-M5	110	M5	4	0.07	-	Manual Drain	
AF2000-01	750	G1/8"	15	0.19	B240		AF2000-01D
AF2000-02		G1/4"				AF2000-02D	
AF3000-02	1500	G1/4"	20	0.29	B340	A. Air Shutoff Drain	AF3000-02D
AF3000-03		G3/8"					AF3000-03D
AF4000-03	4000	G3/8"	45	0.55	B440		AF4000-03D
AF4000-04		G1/2"					AF4000-04D
AF4000-06	6000	G3/4"	45	0.58	B540	B. Manual Drain	AF4000-06D
AF5000-06	7000	G3/4"	130	1.08	B640		AF5000-06D
AF5000-10		G1"					AF5000-10D

A Series Air Treatment Unit

Main Specifications

AF1000-2000

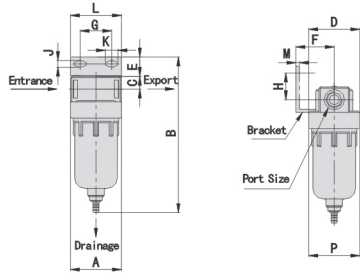

AF3000-4000

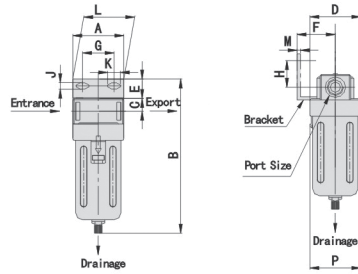

AF5000

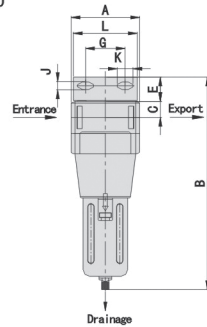

Model	Port Size	A	B	C	D	E	F	G	H	J	K	L	M	P
AF1000	M5	25	66	7	25	-	-	-	-	-	-	-	-	26.5
AF2000	1/8~1/4	40	97.5	11	40	17	30	27	22	5.4	8.4	40	2.3	40
AF3000	1/4~3/8	53	132.5	14	53	16	41	40	23	6.5	8	53	2.3	56
AF4000	3/8~1/2	70	168.5	18	70	17	50	54	26	8.5	10.5	70	2.3	73
AF4000-06	3/4	75	172.5	20	70	14	50	54	25	8.5	10.5	70	2.3	73
AF5000	3/4~1	90	247.5	24	90	23	66.5	66	35	11	13	90	3.2	90

A Series Air Treatment Unit

Ordering Code AR Series Air Regulator

AR 30 00 - 03

10:1000 Valve Body Size
20:2000 Valve Body Size
30:3000 Valve Body Size
40:4000 Valve Body Size
50:5000 Valve Body Size

Joint Size

M5:M5
01:G1/8"
02:G1/4"
03:G3/8"
04:G1/2"
06:G3/4"
10:G1"

Air Regulator



Specifications

Model	Specifications					Accessories
	Rated Flow (L/min)	Joint Size (G)	Pressure Gauge Size	Ensured Pressure Resistance	Max Working Pressure	Bracket
AR1000-M5	100	M5"	G1/16"	1.5MPa	1.0MPa	B120
AR2000-01	550	G1/8"	G1/8"			B220
AR2000-02		G1/4"	G1/8"			B220
AR2500-02	2000	G1/4"	G1/8"			B320
AR2500-03		G3/8"	G1/8"			
AR3000-02	2500	G1/4"	G1/8"			B420
AR3000-03		G3/8"	G1/8"			
AR4000-03	6000	G3/8"	G1/4"			
AR4000-04		G1/2"	G1/4"			
AR4000-06	6000	G3/4"	G1/4"			
AR5000-06	8000	G3/4"	G1/4"			
AR5000-10		G1"				

Main Specifications

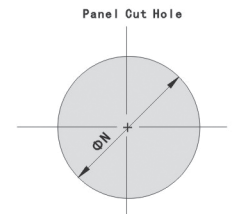
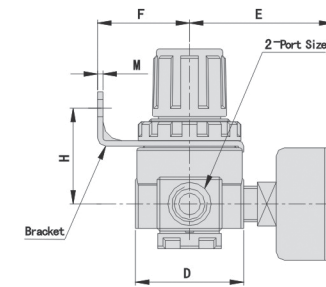
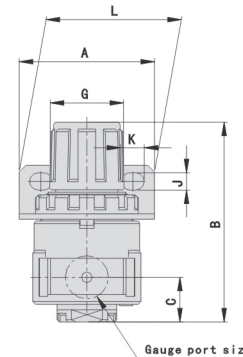

AR1000-3000
Max 3.5
AR4000-5000
Max 5

A Series Air Treatment Unit

AR Series Air Filter Combination

Model	Port Size	A	B	C	D	E	F	G	H	J	K	L	M	N
AR1000	M5	25	61.5	11	25	26	25	28	30	4.5	6.5	40	2	20.5
AR2000	1/8~1/4	40	95	17	40	56.8	30	34	44	5.4	15.4	55	2.3	33.5
AR2500	1/4~3/8	53	102.5	25	48	60.8	30	34	44	5.4	15.4	55	2.3	33.5
AR3000	1/4~3/8	53	127.5	35	53	60.8	39	40	46	6.5	8	53	2.3	42.5
AR4000	3/8~1/2	70	149.5	37.5	70	65.5	49.2	54	54	8.5	10.5	70	2.3	52.5
AR4000-06	3/4	75	154	40.5	70	69.5	49.2	54	55.5	8.5	10.5	70	2.3	52.5
AR5000	3/4~1	90	168	48	90	75.5	49.2	54	62	8.5	10.5	70	2.3	52.5

Ordering Code AL Series Air Lubricator

AL 30 00 - 03

10:1000 Valve Body Size
20:2000 Valve Body Size
30:3000 Valve Body Size
40:4000 Valve Body Size
50:5000 Valve Body Size

M5:M5
01:G1/8"
02:G1/4"
03:G3/8"
04:G1/2"
06:G3/4"
10:G1"

AL Air Lubricator



Specifications

Ensured Pressure Resistance	1.5MPa
Highest Working Pressure	1.0MPa
Ambient and Fluid Temperature	5~60°C
Recommended Oil Use	Turbine No.1 Oil ISOVG32
Cup Material	Polycarbonate
Protective Cover	AL1000~2000 (Not Available) AL3000~5000 (Available)

Model	Specifications					Accessories
	Minimal Flow of Oil Drop (L/min)	Rated Flow (G)	Joint Size (G)	Bowl Capacity (cm ³)	Weight (kg)	Bracket
AL1000-M5	4	95	M5	7	0.07	-
AL2000-01	15	800	G1/8"	25	0.22	B240
AL2000-02			G1/4"			
AL3000-02	30	1700	G1/4"	50	0.30	B340
AL3000-03	40		G3/8"			
AL4000-03	40	5000	G3/8"	130	0.56	B440
AL4000-04	50		G1/2"			
AL4000-06	50	6300	G3/4"	130	0.58	B540
AL5000-06	190	7000	G3/4"	130	1.08	B640
AL5000-10			G1"			

A Series Air Treatment Unit

Main Specifications

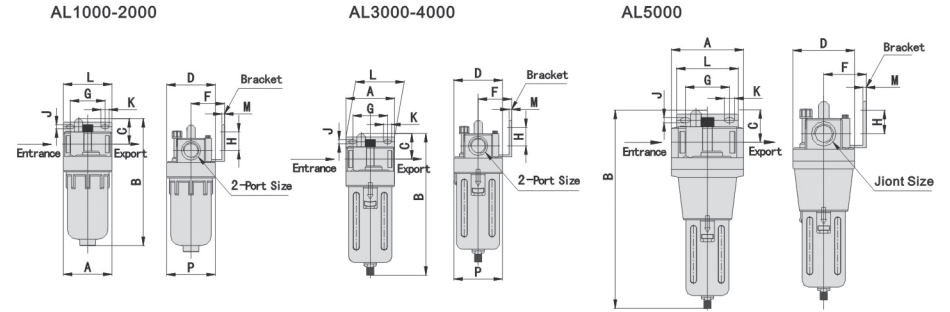

Model	Port Size	A	B	C	D	F	G	H	J	K	L	M	P
AL1000	M5	25	81.5	25.5	25	-	-	-	-	-	-	-	27
AL2000	1/8~1/4	40	122	38	40	30	27	22	5.4	8.4	40	2.3	40
AL3000	1/4~3/8	53	142	38	53	41	40	23	6.5	8	53	2.3	56
AL4000	3/8~1/2	70	177	41	70	50	54	26	8.5	10.5	70	2.3	73
AL4000-06	3/4	75	177	39	70	50	54	25	8.5	10.5	70	2.3	73
AL5000	3/4-1	90	254	45	90	66.5	66	35	11	13	90	3.2	90

Ordering Code AW Series F.R Combination

AW 30 00 - 03 - □

10:1000 Valve Body Size
20:2000 Valve Body Size
30:3000 Valve Body Size
40:4000 Valve Body Size
50:5000 Valve Body Size

Filter Regulator

Joint Size
M5:M5
01:G1/8"
02:G1/4"
03:G3/8"
04:G1/2"
06:G3/4"
10:G1"

Blank: Manual Drain Type
D: Auto Drain Type



Specifications

Ensured Pressure Resistance	1.5MPa
Highest Working Pressure	1.0MPa
Ambient and Fluid Temperature	5~60°C
Filter Precision	25µm
Cup Material	Polycarbonate
Protective Cover	AW1000~2000 (Not Available) AW3000~5000 (Available)
Pressure Regulating Range	AW1000: 0.05~0.7Mpa AW2000~5000: 0.05~0.85Mpa
Valve Type	With Overflow

A Series Air Treatment Unit

AW F.R Combination

Model	Specifications				Accessories		Drain Function	Auto Drain Model
	Rated Flow (L/min)	Joint Size (G)	Pressure Gauge Size	Weight (kg)	Bracket	Pressure Gauge		
AW1000-M5	100	M5	G1/16	0.09	B120	G27-10-R1	Manual Drain	
AW2000-01	550	G1/8"	G1/8	0.36	B220	G36-10-01		AW2000-01D
AW2000-02		G1/4"					AW2000-02D	
AW3000-02	2000	G1/4"	G1/8	0.56	B320	G36-10-01	AW3000-02D	
AW3000-03		G3/8"					AW3000-03D	
AW4000-03	4000	G3/8"	G1/4	1.15	B420	G46-10-02	a.Air Shutoff Drain AW4000-03D	
AW4000-04		G1/2"					AW4000-04D	
AW4000-06	4500	G3/4"	G1/4	1.21	B420	G46-10-02	b.Manual Drain AW4000-06D	
AW5000-06	5500	G3/4"	G1/4	1.70			AW5000-06D	
AW5000-10		G1"					AW5000-10D	

Main Specifications

AW1000-2000

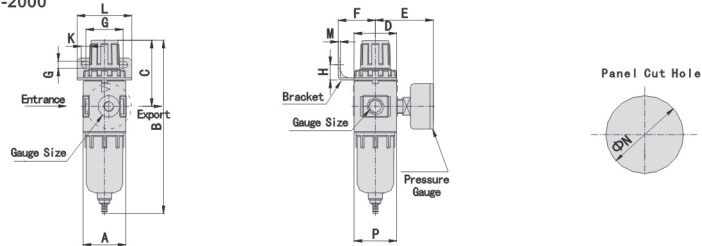

AW3000-5000

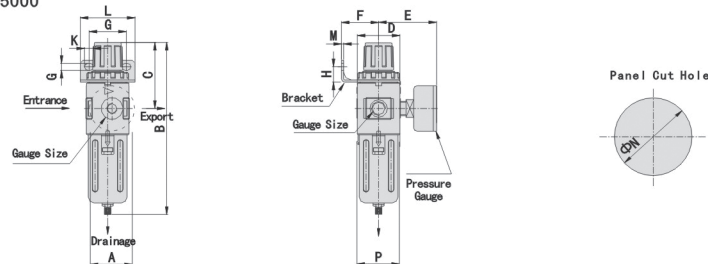

Model	Joint Size	A	B	C	D	F	G	H	J	K	L	M	N	P
AW1000	M5	25	109.5	50.5	25	25	28	30	4.5	6.5	40	2	20.5	28
AW2000	1/8~1/4	40	164.5	78	40	30	34	43.5	5.4	15.4	55	2.3	33.5	40
AW3000	1/4~3/8	53	211	92.5	53	39	40	46	6.5	8	53	2.3	42.5	56
AW4000	3/8~1/2	70	262	112	70	49.2	54	53.5	8.5	10.5	70	2.3	52.5	73
AW4000-06	3/4	75	267	114	70	49.2	54	53.5	8.5	10.5	70	2.3	52.5	73
AW5000	3/4-1	90	338	116	90	49.2	54	62	8.5	10.5	70	2.3	52.5	90

V Series F.R.L With Embedded Air Gauge The Body



Model	Joint Size
VF2-01	G1/8"
VF2-02	G1/4"
VF3-02	G1/4"
VF3-03	G3/8"
VF3-04	G1/2"

Ordering Code

VF 2 - 0 1 - D - □

VF2:2 Series Filter
VF3:3 Series Filter

Joint Size
01:G1/8"
02:G1/4"
03:G3/8"
04:G1/2"

Drain Type
Blank:Air Shutoff Drain
D:Auto Drain Type

J:With Bracket
□:No Bracket



Model	Joint Size
VR2-01	G1/8"
VR2-02	G1/4"
VR3-02	G1/4"
VR3-03	G3/8"
VR3-04	G1/2"

Ordering Code

VR 2 - 0 1 - □ - P

VR2:2 Series Regulator
VR3:3 Series Regulator

Joint Size
01:G1/8"
02:G1/4"
03:G3/8"
04:G1/2"

J:With Bracket
□:No Bracket

Gauge Type
P:Square Gauge



Model	Joint Size
VL2-01	G1/8
VL2-02	G1/4
VL3-02	G1/4
VL3-03	G3/8
VL3-04	G1/2

Ordering Code

VL 2 - 0 1

VL2:2 Series Lubricator
VL3:3 Series Lubricator

Joint Size
01:G1/8"
02:G1/4"
03:G3/8"
04:G1/2"



Model	Joint Size
VFR2-01	G1/8
VFR2-02	G1/4
VFR3-02	G1/4
VFR3-03	G3/8
VFR3-04	G1/2

Ordering Code

VFR 2 - 0 1 - □ - □ - P

VFR2:2 Series Filter Regulator
VFR3:3 Series Filter Regulator

Joint Size
01:G1/8"
02:G1/4"
03:G3/8"
04:G1/2"

Drain Type
Blank:Air Shutoff Drain
D:Auto Drain Type

J:With Bracket
□:No Bracket

Gauge Type
P:Square Gauge



Model	Joint Size
VFC2-01	G1/8
VFC2-02	G1/4
VFC3-02	G1/4
VFC3-03	G3/8
VFC3-04	G1/2

Ordering Code

VFC 2 - 0 1 - □ - P

VFC2:2 Series Filter Regulator+Lubricator
VFC3:3 Series Filter Regulator+Lubricator

Joint Size
01:G1/8"
02:G1/4"
03:G3/8"
04:G1/2"

Drain Type
Blank:Air Shutoff Drain
D:Auto Drain Type

J:With Bracket
□:No Bracket

Gauge Type
P:Square Gauge



Model	Joint Size
VC2-01	G1/8
VC2-02	G1/4
VC3-02	G1/4
VC3-03	G3/8
VC3-04	G1/2

Ordering Code

VC 2 - 0 1 - □ - P

VC2:2 Series Filter+Regulator+Lubricator
VC3:3 Series Filter+Regulator+Lubricator

Joint Size
01:G1/8"
02:G1/4"
03:G3/8"
04:G1/2"

Drain Type
Blank:Air Shutoff Drain
D:Auto Drain Type

J:With Bracket
□:No Bracket

Gauge Type
P:Square Gauge

A/B Series Air Treatment Unit



AF Series

Model	Auto Drain Model	Joint size
AF1500	AF1500D	1/8
AF2000	AF2000D	1/4



AL Series

Model	Joint size
AL1500	1/8
AL2000	1/4



AFR Series

Model	Auto Drain Model	Joint size
AFR1500	AFR1500D	1/8
AFR2000	AFR2000D	1/4



AFC Series

Model	Auto Drain Model	Joint size
AFC1500	AFC1500D	1/8
AFC2000	AFC2000D	1/4



AC Series

Model	Auto Drain Model	Joint size
AC1500	AC1500D	1/8
AC2000	AC2000D	1/4



AR Series

Model	Joint size
AR1500	1/8
AR2000	1/4



BF Series

Model	Auto Drain Model	Joint size
BF2000	BF2000D	1/4
BF3000	BF3000D	3/8
BF4000	BF4000D	1/2



BL Series

Model	Joint size
BL2000	1/4
BL3000	3/8
BL4000	1/2



BFR Series

Model	Auto Drain Model	Joint size
BFR2000	BFR2000D	1/4
BFR3000	BFR3000D	3/8
BFR4000	BFR4000D	1/2



BFC Series

Model	Auto Drain Model	Joint size
BFC2000	BFC2000D	1/4
BFC3000	BFC3000D	3/8
BFC4000	BFC4000D	1/2



BC Series

Model	Auto Drain Model	Joint size
BC2000	BC2000D	1/4
BC3000	BC3000D	3/8
BC4000	BC4000D	1/2

F.R.L Brackets

Spacer with L-Bracket



Model	Applicable Model
Y10L	AC1000
Y20L	AC2000
Y30L	AC2500-3000
Y40L	AC4000
Y50L	AC4000-06
Y60L	AC5000

L-Type Bracket



Model	Applicable Model
B110L	AC1000
B210L	AC2000
B310L	AC2500/3000
B410L	AC4000
B510L	AC4000-06
B610L	AC5000

Spacer with T-Type Bracket



Model	Applicable Model
Y10T	AC1000
Y20T	AC2010
Y30T	AC3010
Y40T	AC4010
Y50T	AC4010-06
Y60T	AC5010

T-Type Bracket



Model	Applicable Model
B110T	AC1010
B210T	AC2010
B310T	AC2510/3010
B410T	AC4010
B510T	AC4010-06
B610T	AC5010

T-Type Spacer



Model	Applicable Model
Y21-01/Y21-02	AC2000
Y31-01/Y31-02	AC2000
Y41-01/Y41-02	AC4000
Y61-03/Y61-04	AC5000

20-Type Bracket



Model	Applicable Model
B120	AR1000 AW1000
B220	AR2000-2500 AW2000-2500
B320	AR3000 AW3000
B420	AR4000-5000 AW4000-5000

40-Type Bracket



Model	Applicable Model
B240	AF2000 AL2000
B340	AF3000 AL3000
B440	AF4000 AL4000
B540	AF4000-06 AL4000-06
B640	AF5000 AL5000

Auto Drain Element



Model
ZDFS-06
ZDFS-08

Auto Drain



Model
HAD402-02
HAD402-03
HAD402-04